

Product Finish: Chrome

Product code: PT1007
EAN13 barcode: 5060344152983



Product features:

- Stylish 4 way mixer tap delivering domestic hot and cold, ambient and 80-98° filtered water.
- Supplied with 2 x patent pending proximity Hotkey™ activation for 80-98° water, without the Hotkey™ the product reverts to a family safe 3 way mixer.
- 360° rotating thermally insulated spout
- Ceramic disc ¼ turn smooth action control valves
- Hands free dispensing of 80-98° water possible for heavy pans
- Anti splash aerator as standard

Product dimensions:

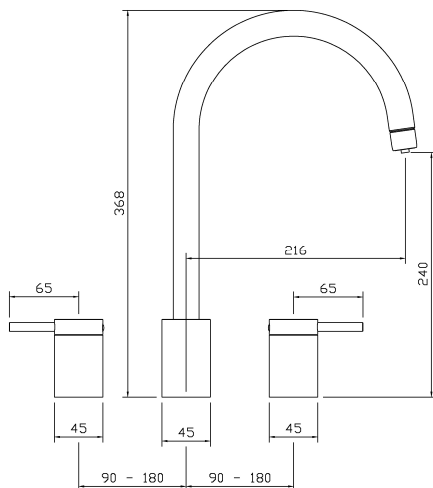

- **Overall Height / projection:** 368 mm
- **Exit reach:** 216 mm
- **Exit height:** 240 mm
- **Centre distance(s):** 90 - 180
- **Base diameter(s):** 45 x 45 x 45 mm
- **Recommended hole diameter:** Ø35 mm
- **Max. surface depth:** 50 mm
- **Spout diameter:** 24 mm
- **Spout aerator size:** M22x1 Male

Product flow characteristics:

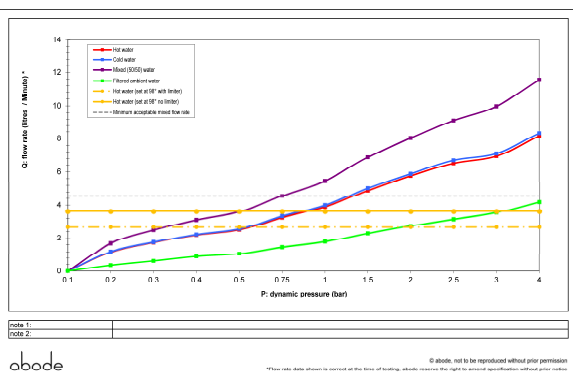

- **Min / Max water pressure:** 0.75 / 5.5 bar (mixertap only)
- **Recommended / Max incoming domestic hot water temperature:** 46°C / 70°C
- **Part G - Mixed flow rate at 3 bar (litres / min):** 9.97
- **Control valve type:** 1 x Ceramic disc QT hot, 1 x Diverter Cold/Filter
- **Product flow characteristics:** (C,H&F/Boiling) dual flow
- **Aerator type:** Neoperl aerator honeycomb dual flow
- **Hot and Cold inlet connections:** M10 x 1/2" M x 365mm flexi hose
- **Non return valve(s):** Yes, integral to hot and cold supplies

Care instructions summary:

- Clean the product regularly as required, using a mild soap and damp cloth, do not use any other cleaners, regular cleaning will prevent the build-up of lime scale and dirt
- Residues of sink & worktop cleaners can also cause damage to the mixer tap, so rinse with clean water after using, avoid contact with any abrasives

Warranty Summary (Full details available on request):

- Mixer tap Materials and workmanship defects warranted for 5 years
- Proboil3 Materials and workmanship defects warranted for 2 years
- Mixer tap Valves and working parts warranted for 5 years
- Surface finish warranty defects warranted for 1 year
- All o-rings, hoses & gaskets warranted for 1 year



PROBOIL3 features:

- 80-98°C variable stored water temperature
- 3.5 litres maximum continuous draw off
- 50 cups per hour recovery rate
- Electronically controlled hot water system to ensure the first cup to the last are equally hot.
- Pumped delivery to ensure smooth flow with no spitting
- High quality stainless steel tank construction
- UK manufactured
- Choice of energy saving Eco modes
- Choice of 9 languages
- On screen service notifications with QR code links to user 'how to' maintenance videos
- Filter status indicator bar
- Child lock function
- Intelligent descale notification, user drainable & descalable
- Dimensions: 175mm (w) x 400mm (d) x 410mm (h)
- Weight (when full): 12.5Kg
- Power rating: 2.8kW, 220-240V 50Hz, 13A
- Pressure rating (min – max): 2-8 bar
- Boiler approvals: BS EN 60335-2-75:2004 +A2:2008, LVD (2014/35/EU), EMC (2014/30/EU), CE (93/68/EEC), RoHS(2011/65/EU)

*All temperatures quoted are measured within the tank of the boiler and actual spout exit temperature may vary dependant on local conditions.

For further information refer to proboil.co.uk and our user guides.



Our premium quality **PROBOIL** filter offers the following benefits:

- Filtered ambient and 80-98°C drinking water, engineered specifically for hot and ambient water applications
- Included with every **PROBOIL** system
- 6 month life (based on 19 degrees Clark (London average hardness) and 5 litres per day usage)
- Superfine 5 micron carbon block filtration
- Chlorine taste and odour reduction.
- pH balanced delivery
- Adjustable hardness settings allows optimised filter life and boiler scale protection
- Inbuilt corrosion protection
- Mineral adaption and scale reduction for protection
- Simple quarter turn bayonet installation
- Automated on screen life reminder



The complete package:

Each **PRONTEAU** system includes:

- A stylish choice of intelligent 4 way **PRONTEAU** mixer taps
- 2 x 4 way mixer tap Hotkeys
- **PROBOIL3** boiler
- **PROBOIL** premium scale filter and head
- Connecting hoses, safety devices and plumbing sundries
- Comprehensive installer and user guides
- User draining kit
- Nationwide professional installation service available on request
- Nationwide professional maintenance and service support
- Extended warranties and service plans available on request

WATER THE WAY YOU WANT IT