

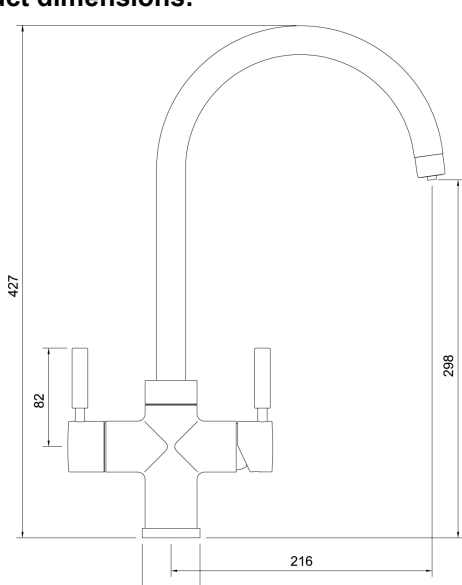

Product Features:

- Stylish 3 way mixer tap delivering domestic hot, cold and 98° filtered water
- The dual stage handle mechanism on the hot handle has been designed with safety and ease of use in mind
- 360 degree rotation of spout allows for easy use and accessibility
- Anti splash aerator as standard
- Features an energy saving cold start valve as standard
- 5 Year Warranty*
- WRAS approval pending

Product dimensions:



- **Overall Height / projection:** 427mm
- **Exit spout reach:** 216 mm
- **Exit spout height:** 298 mm
- **Base diameter(s):** 48 mm
- **Recommended hole diameter:** Ø35 mm
- **Max. surface depth:** 50 mm
- **Spout diameter:** 24 mm
- **Spout aerator size:** M22x1 Male

Product flow characteristics:

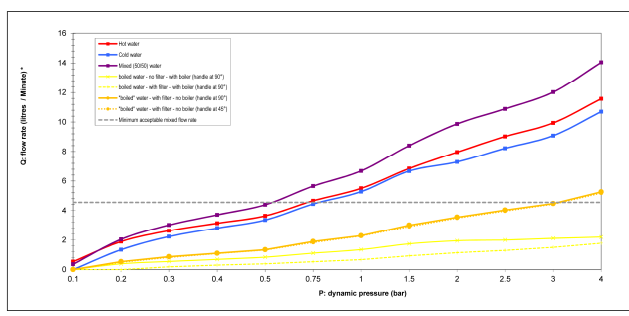

- **Min cold water pressure:** 1.5 bar
- **Min hot water pressure:** 0.75 bar
- **Recommended / Maximum domestic hot water temperature:** 46°C / 70°C
- **Part G - Mixed flow rate at 3 bar (litres / min):** 12.02
- **Control valve type:** 1 x 1/2" Ceramic disc QT, 1 x Single lever 35mm
- **Product flow characteristics:** (H&C/Boiling) dual flow
- **Aerator type:** Neoperl aerator honeycomb
- **Hot and Cold inlet connections:** flexi hose
- **Non return valve(s):** Yes, integral to cold inlet flexi hose only

Care instructions summary:

- Clean the product regularly as required, using a mild soap and damp cloth, do not use any other cleaners, regular cleaning will prevent the build-up of lime scale and dirt
- Residues of sink & worktop cleaners can also cause damage to the mixer tap, so rinse with clean water after using, avoid contact with any abrasives

Warranty Summary (Full details available on request):

- Mixer tap materials and workmanship defects warranted for 5 years
- Probol2 materials and workmanship defects warranted for 2 years
- Mixer tap valves and working parts warranted for 5 years
- Surface finish warranty defects warranted for 1 year
- All o-rings, hoses & gaskets warranted for 1 year



PROBOIL2 features:

- Compact size to fit discreetly into your base unit (Overall height 257mm, Width 217mm, Depth 175mm)
- Filtered water inlet
- 98 degree water outlet
- Safety steam vent to a standard dishwasher connection
- Removable tank lid for easy access, cleaning and descale
- 2 Litre tank
- Boiler can be floor or wall mounted
- UK manufactured boiler
- 2 Year Warranty*
- WRAS approval pending

*All temperatures quoted are measured within the tank of the boiler and actual spout exit temperature may vary dependant local conditions.

For further information refer to proboil.co.uk and our user guide.

Our premium quality PROBOIL2 filter offers the following benefits:



- Filtered 98°C drinking water, engineered specifically for hot water applications
- Included with every PROBOIL2 system
- Recommended / Maximum replacement interval: 6 / 12 months
- Chlorine taste and odour reduction.
- Inbuilt corrosion protection
- Mineral adaption and scale reduction for protection
- Reduces scaling potential of the water
- WRAS approved



The complete package:

Each PRONTEAU system includes:

- A stylish choice of intelligent 3 way PRONTEAU mixer taps
- PROBOIL2 hot water boiler
- PROBOIL2 scale control filter & assembly
- Connecting hoses and safety vent
- Comprehensive user and installation guide
- Waste Plumbing Attachments
- Nationwide professional maintenance and service support

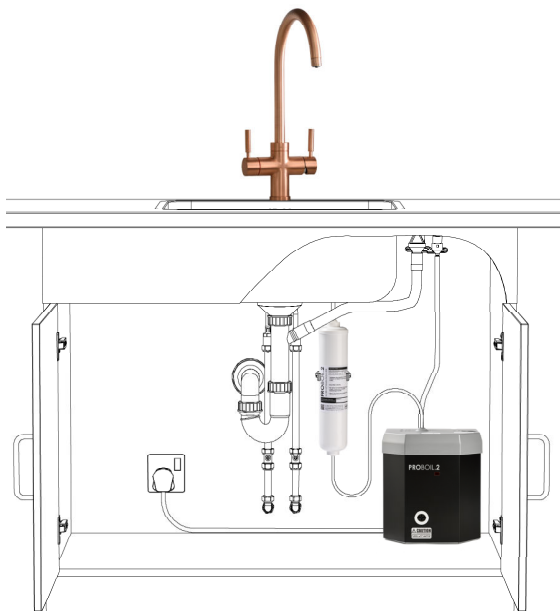

WATER THE WAY YOU WANT IT